

Shenzhen Owire Co., Ltd.



EMC REPORT

Prepared For :	Shenzhen Owire Co., Ltd. 302, Dadi factory building, No. 8 Cichang road, Bao' an community, Yuanshan street, Longgang district, Shenzhen City, Guangdong Province, P.R. China
Product Name:	NETWORK CABLE
Trademark	OWIRE
Main Test Model :	CAT5E
Additional Model:	CAT6
Prepared By :	Rhenish-Lab Certification & Testing (Shenzhen) Co., Ltd. 101, Building B, Bailu Plaza, No.48, Gonghe Industrial Road, Gongle, Xixiang Subdistrict, Bao'an District, Shenzhen, Guangdong, China
Test Date:	July 21, 2025 to July 24, 2025
Date of Report :	July 26, 2025
Report No.:	RLT2507256-01

TABLE OF CONTENTS

TEST REPORT DECLARATION	3
1. TEST RESULTS SUMMARY	4
2. GENERAL INFORMATION	5
2.1. Report information	5
2.2. Measurement Uncertainty	5
3. PRODUCT DESCRIPTION	6
3.1. EUT Description	6
3.2. Block Diagram of EUT Configuration	6
3.3. Operating Condition of EUT	6
3.4. Test Conditions	6
3.5. Modifications	6
3.6. Abbreviations	7
3.7. Performance Criterion	7
4. TEST EQUIPMENT USED	8
4.1. For Conducted Emission Test	8
4.2. For Magnetic Test (In Shielding Room)	8
4.3. For Radiated Emission Measurement	8
4.4. For Harmonic / Flicker Test	8
4.5. For Electrostatic Discharge Immunity Test	8
4.6. For RF Strength Susceptibility Test	8
4.7. For Electrical Fast Transient/Burst Immunity Test	9
4.8. For Surge Test	9
4.9. For Injected Currents Susceptibility Test	9
4.10. For Magnetic Field Immunity Test	9
4.11. For Voltage Dips and Interruptions Test	9
5. EMISSION TEST	10
5.1. Power Line Conducted Emission Test	10
5.2. Radiated Emission	11
5.3. Harmonic Current Emissions	14
5.4. Voltage Changes, Voltage Fluctuations and Flicker	15
6. IMMUNITY TEST	16
6.1. ESD	16
6.2. RF Field Strength Susceptibility Test	17
6.3. Electrical Fast Transients/Burst Test	18
6.4. Injected Currents Susceptibility Test	19
6.5. Surge Test	20
6.6. Voltage dips and Interruption	21
APPENDIX I	22
APPENDIX II	错误！未定义书签。

TEST REPORT DECLARATION

Applicant	:	Shenzhen Owire Co., Ltd.
Address	:	302, Dadi factory building, No. 8 Cichang road, Bao'an community, Yuanshan street, Longgang district, Shenzhen City, Guangdong Province, P.R. China
EUT Description	:	NETWORK CABLE
Model Number	:	CAT5E, CAT6 The appearance is the same, the internal structure diagram is the same, but the model naming is different, and the CAT5E model is used for testing.

Test Standards:

EN 55032:2015+A11:2020
EN 55035:2017+A11:2020

This report shows that the EUT technically complies with the 2014/30/EU directive and its amendment requirements.

The test report is valid for above tested sample only and shall not be reproduced in part without written approval of the laboratory.

Prepared by :

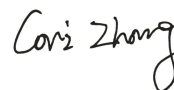

Assistant

Reviewer :

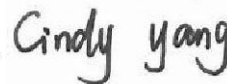

Supervisor

Approved & Authorized Signer :



Manager

1. TEST RESULTS SUMMARY

Table 1 Test Results Summary

Test Items	Test Results
Power Line Conducted Emission Test	N/A
Radiated Emission Test	PASS
Harmonic Current Emission Test	N/A
Voltage Fluctuations & Flicker Test	N/A
Electrostatic Discharge Test	PASS
RF Field Strength Susceptibility Test	PASS
Electrical Fast Transient/Burst Test	N/A
Surge Test	N/A
Injected Currents Susceptibility Test	N/A
Voltage Dips And Interruptions Test	N/A

2. GENERAL INFORMATION

2.1. Report information

- 2.1.1. This report is not a certificate of quality; it only applies to the sample of the specific product/equipment given at the time of its testing. The results are not used to indicate or imply that they are application to the similar items. In addition, such results must not be used to indicate or imply that RLT approves recommends or endorses the manufacture, supplier or use of such product/equipment, or that RLT in any way guarantees the later performance of the product/equipment.
- 2.1.2. The sample/s mentioned in this report is/are supplied by Applicant, RLT therefore assumes no responsibility for the accuracy of information on the brand name, model number, origin of manufacture or any information supplied.
- 2.1.3. Additional copies of the report are available to the Applicant at an additional fee. No third part can obtain a copy of this report through RLT, unless the applicant has authorized RLT in writing to do so.

2.2. Measurement Uncertainty

Available upon request.

3. PRODUCT DESCRIPTION

3.1.EUT Description

Description	:	NETWORK CABLE
Applicant	:	Shenzhen Owire Co., Ltd. 302, Dadi factory building, No. 8 Cichang road, Bao'an community, Yuanshan street, Longgang district, Shenzhen City, Guangdong Province, P.R. China
Manufacturer	:	Shenzhen Owire Co., Ltd. 302, Dadi factory building, No. 8 Cichang road, Bao'an community, Yuanshan street, Longgang district, Shenzhen City, Guangdong Province, P.R. China
Model Number	:	CAT5E, CAT6 The appearance is the same, the internal structure diagram is the same, but the model naming is different, and the CAT5E model is used for testing.

3.2.Block Diagram of EUT Configuration



3.3.Operating Condition of EUT

Test mode 1: ON

3.4.Test Conditions

Temperature: 23-26°C
Relative Humidity: 55-68 %

3.5.Modifications

No modification was made.

3.6. Abbreviations

AC	Alternating Current
AMN	Artificial Mains Network
DC	Direct Current
EM	ElectroMagnetic
EMC	ElectroMagnetic Compatibility
EUT	Equipment Under Test
IF	Intermediate Frequency
RF	Radio Frequency
rms	root mean square
EMI	Electromagnetic Interference
EMS	Electromagnetic Susceptibility

3.7. Performance Criterion

Criterion A: The equipment shall continue to operate as intended without operator intervention. No degradation of performance or loss of function is allowed below a performance level specified by the manufacturer when the equipment is used as intended.

Criterion B: After the test, the equipment shall continue to operate as intended without operator intervention. No degradation of performance or loss of function is allowed, after the application of the phenomena below a performance level specified by the manufacturer, when the equipment is used as intended.

Criterion C: Loss of function is allowed, provided the function is self-recoverable, or can be restored by the operation of the controls by the user in accordance with the manufacturer's instructions.

4. TEST EQUIPMENT USED

4.1. For Conducted Emission Test

Item	Equipment	Manufacturer	Model No.	Serial No.
1.	Test Receiver	Rohde & Schwarz	ESHS30	828985/018
2.	Pulse Limiter	Rohde & Schwarz	ESH3-Z2	100006
3.	L.I.S.N.	Rohde & Schwarz	ESH2-Z5	834549/005
4.	Conical	Emtek	N/A	N/A
5.	Voltage Probe	Schwarzbeck	TK9416	N/A
6.	Coaxial Switch	Anritsu	MP59B	6100214550

4.2. For Magnetic Test (In Shielding Room)

Item	Equipment	Manufacturer	Model No.	Serial No.
1.	Test Receiver	Rohde & Schwarz	ESHS20	836600/006
2.	Triple-loop Antenna	Rohde & Schwarz	HM020	843885/002
3.	RF Cable	MIYAZAKI	5D-2W	Tri-loop Cable
4.	Coaxial Switch	Anritsu	MP59B	M73989

4.3. For Radiated Emission Measurement

Item	Equipment	Manufacturer	Model No.	Serial No.
1.	Spectrum Analyzer	ANRITSU	MS2661C	6200140915
2.	Test Receiver	Rohde&Schwarz	ESC830	828982/018
3.	Bilog Antenna	Schwarzbeck	VULB9163	142
4.	50 Coaxial Switch	Anritsu Corp	MP59B	6100237248
5.	Cable	Schwarzbeck	AK9513	ACRX1
6.	Cable	Rosenberger	N/A	FR2RX2
7.	Cable	Schwarzbeck	AK9513	CRRX2
8.	Cable	Schwarzbeck	AK9513	CRRX2
9.	Signal Generator	HP	864A	3625U00573

4.4. For Harmonic / Flicker Test

Item	Equipment	Manufacturer	Model No.	Serial No.
1.	Power Frequency test system	HAEFELY	PHF555	080419-03

4.5. For Electrostatic Discharge Immunity Test

Item	Equipment	Manufacturer	Model No.	Serial No.
1.	ESD Tester	HAEFELY	PSD 1600	H911'292

4.6. For RF Strength Susceptibility Test

Item	Equipment	Manufacturer	Model No.	Serial No.
1.	Signal Generator	HP	8648A	3633A02081
2.	Amplifier	A&R	500A100	17034
3.	Amplifier	A&R	100W/1000M1	17028
4.	Isotropic Field Monitor	A&R	FM2000	16829
5.	Isotropic Field Probe	A&R	FLW220100	16755
6.	Biconic Antenna	EMCO	3108	9507-2534
7.	Log-periodic Antenna	A&R	ADM02080	16812

8.	PC	N/A	486DX2	N/A
----	----	-----	--------	-----

4.7.For Electrical Fast Transient/Burst Immunity Test

Item	Equipment	Manufacturer	Model No.	Serial No.
1.	Burst Tester	HAEFELY	PEFT 4010	080981-16

4.8.For Surge Test

Item	Equipment	Manufacturer	Model No.	Serial No.
1.	Surge Tester	HAEFELY	PSURGE4.1	080107-04

4.9.For Injected Currents Susceptibility Test

Item	Equipment	Manufacturer	Model No.	Serial No.
1.	Simulator	EMTEST	CWS 500C	0900-12
2.	CDN	EMTEST	CDN-M2	510010010010
3.	VDN	EMTEST	CDN-M3	0900-11
4.	Injection Clamp	EMTEST	F-2031-23MM	368
5.	Attenuator	EMTEST	ATT6	0010222a

4.10.For Magnetic Field Immunity Test

Item	Equipment	Manufacturer	Model No.	Serial No.
1.	Magnetic Field Tester	HEAFELY	MAG100.1	083858-10

4.11.For Voltage Dips and Interruptions Test

Item	Equipment	Manufacturer	Model No.	Serial No.
2.	Dips Tester	HEAFELY	PLINE 1610	083732-18

5. EMISSION TEST

5.1. Power Line Conducted Emission Test

This clause lays down the general requirements for the measurement of disturbance voltage produced at the terminals of apparatus.

5.1.1. Measurement procedure

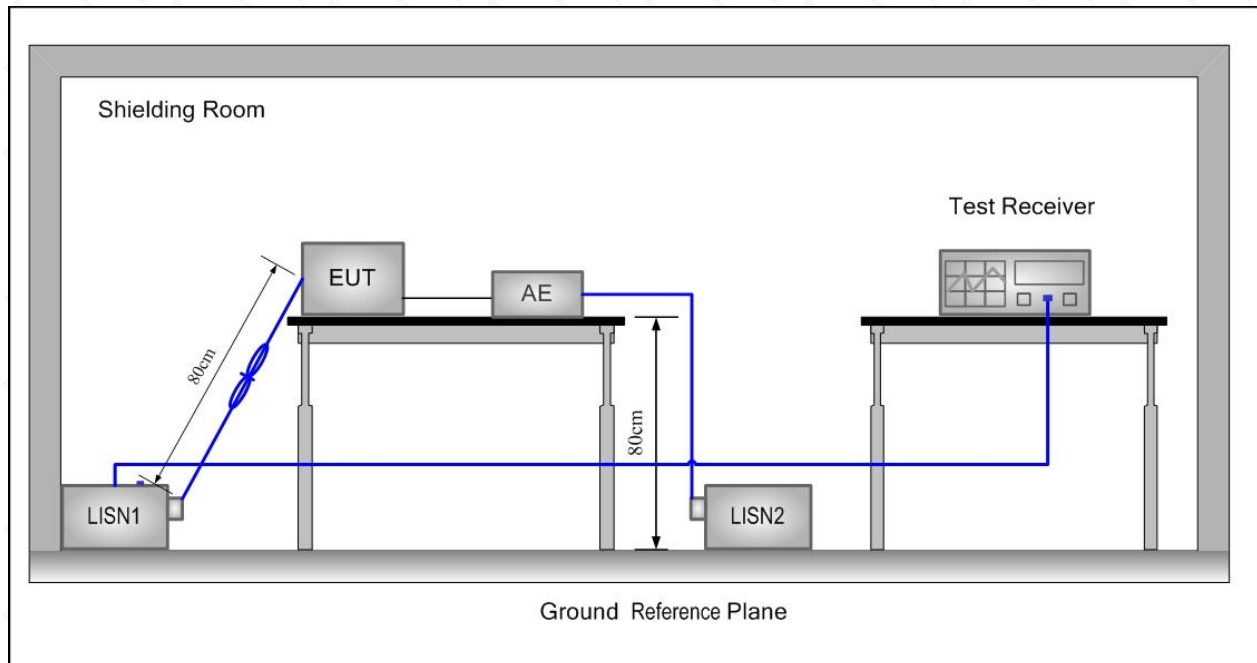

1. The mains terminal disturbance voltage was measured with the EUT in a shielded room.
2. The EUT was connected to AC power source through a LISN (Line Impedance Stabilization Network) which provides a $(50 \mu\text{H} + 5 \Omega) \parallel 50 \Omega$ linear impedance. The power cables of all other units of the EUT were connected to a second LISN, which was bonded to the ground reference plane in the same way as the LISN for the unit being measured.
3. The tabletop EUT was placed upon a non-metallic table 0.8m above the ground reference plane. And for floor-standing arrangement, the EUT was placed on the horizontal ground reference plane, but separated from metallic contact with the ground reference plane by 0.1m of insulation.
4. Before get the final emission results with quasi-peak(QP) detector and average(AV) detector, a pre-scan was performed with the peak(PK) and average(AV) detector to find out the maximum emission data plots of the EUT.

5.1.2. Measurement uncertainty

$U_{\text{lab}}(\text{cond}) = 1.8\text{dB}$ at 95% level of confidence, $K=2$

5.1.3. Results -Measurement Data

N/A

5.2. Radiated Emission

This clause lays down the general requirements for the measurement of Radiated disturbance produced at the space of apparatus.

5.2.1. Measurement procedure

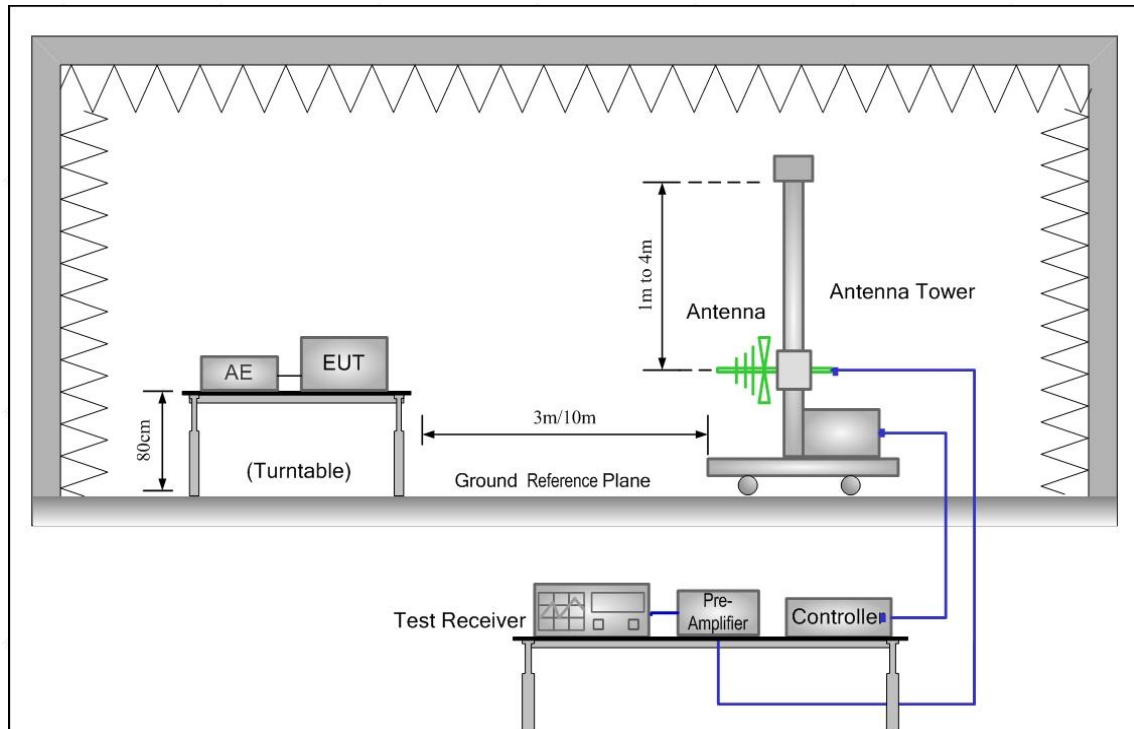

1. The radiated emissions test was conducted in a semi-anechoic chamber. The EUT was placed upon a non-metallic table 0.8m above the ground reference plane. And for floor-standing arrangement, the EUT was placed on the horizontal ground reference plane, but separated from metallic contact with the ground reference plane by 0.1m of insulation.
2. Before get the final emission results with quasi-peak(QP) detector, a pre-scan was performed with the peak(PK) detector to find out the maximum emission data plots of the EUT.
3. The frequencies of maximum emission were determined in the final radiated emissions measurement, the physical arrangement of the test system and associated cabling was varied in order to determine the effect on the EUT's emissions in amplitude, direction and frequency. At each frequency, the EUT was rotated 360°, and the antenna was raised and lowered from 1 to 4 meters in order to determine the maximum disturbance. Measurements were performed for both horizontal and vertical antenna polarization. Test was performed on subcontractor at 3 m distance.

5.2.2. Measurement uncertainty

$U_{lab}(cond) = 3.9dB$ at 95% level of confidence, $k=2$

5.2.3.Results

Horizontal



Site LAB

Limit: EN 55032 CLASS B

EUT:

M/N:

Mode:

Note:

Polarization: **Horizontal**

Power:

Distance: 3m

Temperature:

Humidity: %

No. Mk.	Freq. MHz	Reading Level dBuV	Correct Factor dB	Measurement dBuV/m	Limit dB/m	Over dB	Detector	Antenna Height cm	Table Degree degree	Comment
1	50.0566	31.12	-11.66	19.46	40.00	-20.54	peak			
2	64.6594	36.33	-13.17	23.16	40.00	-16.84	peak			
3	135.0319	36.83	-11.66	25.17	40.00	-14.83	peak			
4	593.0497	29.45	-3.96	25.49	47.00	-21.51	peak			
5	742.2587	31.48	-1.03	30.45	47.00	-16.55	peak			
6 *	916.0687	31.34	1.60	32.94	47.00	-14.06	peak			

Vertical

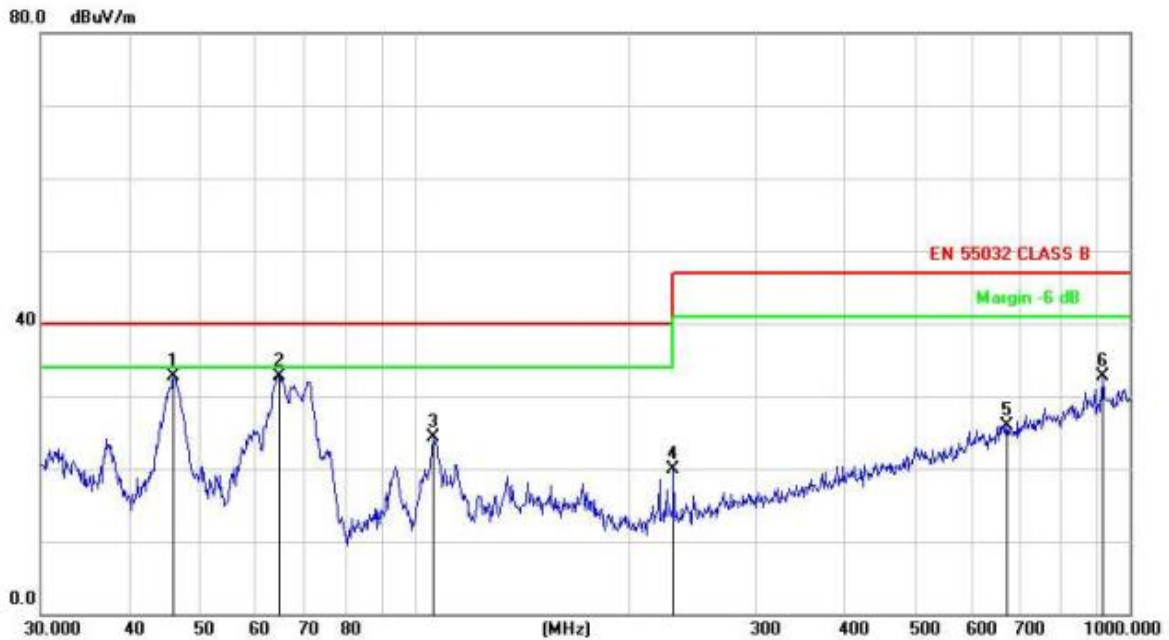

Site LAB

Limit: EN 55032 CLASS B

EUT:

M/N:

Mode:

Note:

Polarization: **Vertical**

Power:

Distance: 3m

Temperature:

Humidity: %

No.	Mk.	Freq. MHz	Reading Level dBuV	Correct Factor dB	Measure- ment dBuV/m	Limit dB/m	Over dB	Antenna Height cm	Table Degree degree	Comment
1	*	46.0164	44.39	-11.59	32.80	40.00	-7.20	peak		
2		64.6594	45.86	-13.17	32.69	40.00	-7.31	peak		
3		106.3850	38.86	-14.56	24.30	40.00	-15.70	peak		
4		230.0985	33.56	-13.59	19.97	47.00	-27.03	peak		
5		672.8444	28.13	-2.23	25.90	47.00	-21.10	peak		
6		916.0687	31.19	1.60	32.79	47.00	-14.21	peak		

5.3. Harmonic Current Emissions

This part deals with the limitation of harmonic currents injected into the public supply system.

5.3.1. Limits

Table 12 Harmonic Current Test Limit (Class A)

Harmonic order (n)	Maximum permissible harmonic current (A)
Odd harmonics	
3	2.30
5	1.14
7	0.77
9	0.40
11	0.33
13	0.21
$15 \leq n \leq 39$	$0.15 \times 15/n$
Even harmonics	
2	1.08
4	0.43
6	0.30
$8 \leq n \leq 40$	$0.23 \times 8/n$

5.3.2. Measurement procedure

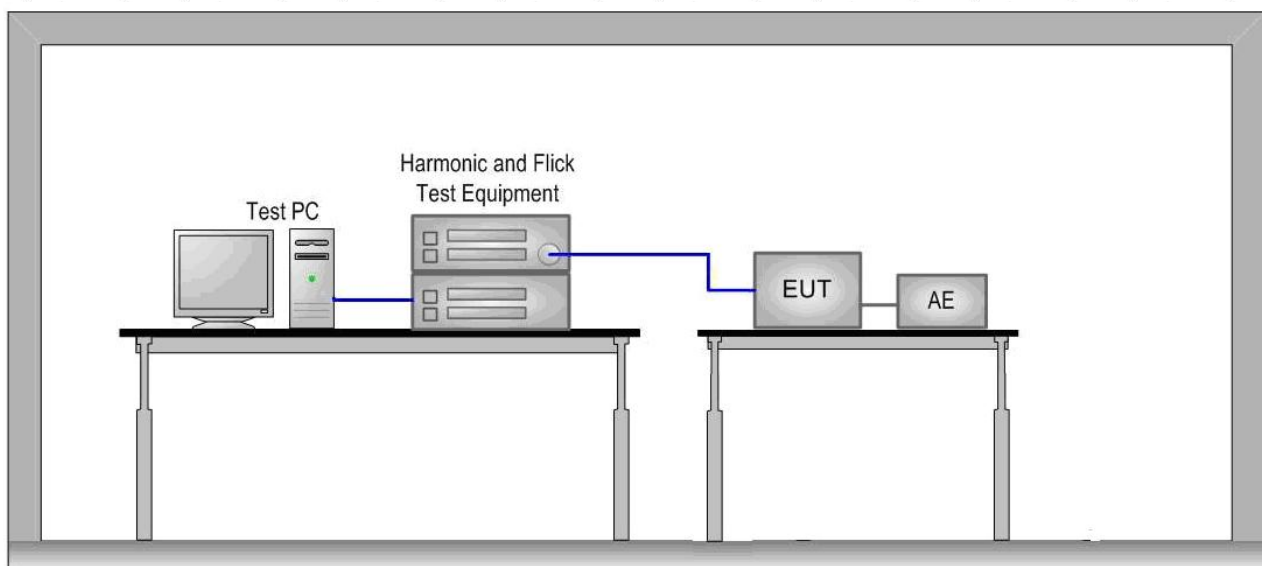

The equipment under test is placed on a wooden table with a height of 0,8 m in the EMC lab. For each harmonic order, measure the 1,5 s smoothed r.m.s. harmonic current in each DFT time window and calculate the arithmetic average of the measured values from the DFT time windows, over the entire observation period. Each harmonic order, all 1.5 s smoothed r.m.s. harmonic current values and the average values for the individual harmonic currents, taken over the entire test observation period shall be less than or equal to the applicable limits.

5.3.3.Results

Test Result: N/A

5.4.Voltage Changes, Voltage Fluctuations and Flicker

This part is concerned with the limitation of voltage fluctuations and flicker impressed on the public low-voltage system.

5.4.1.Measurementtest procedure

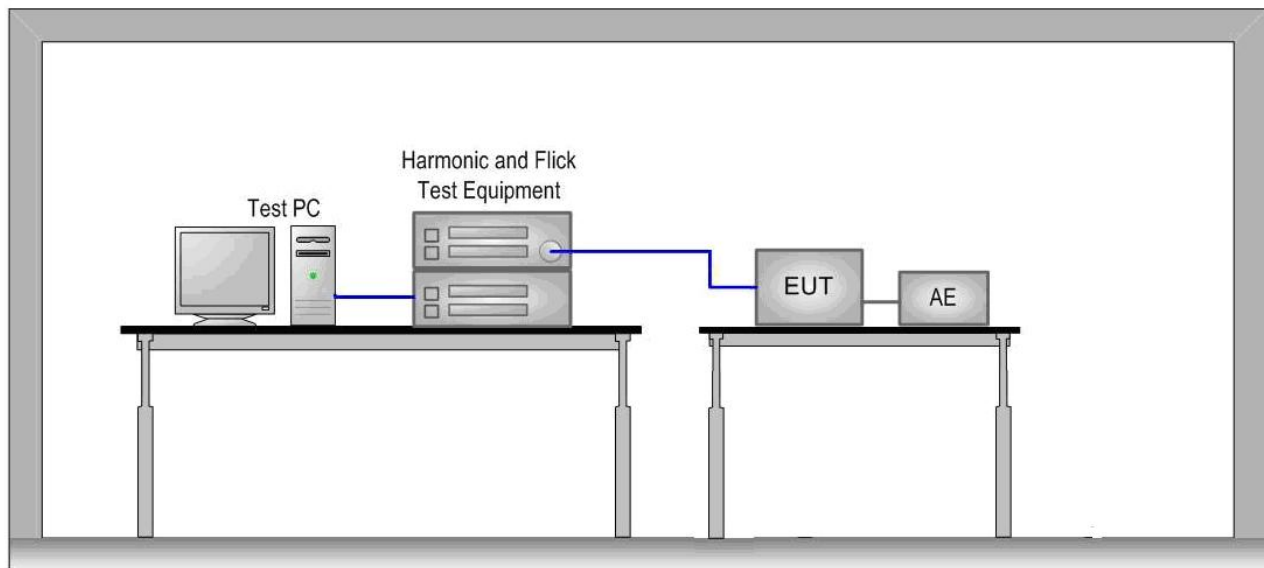

The equipment under test is placed on a wooden table with a height of 0,8 m in the EMC lab. The voltage changes, fluctuations and flicker were measured at the supply terminals of the EUT.

5.4.2.Results

Test Result: N/A

6. IMMUNITY TEST

6.1.ESD

6.1.1.Test Procedures

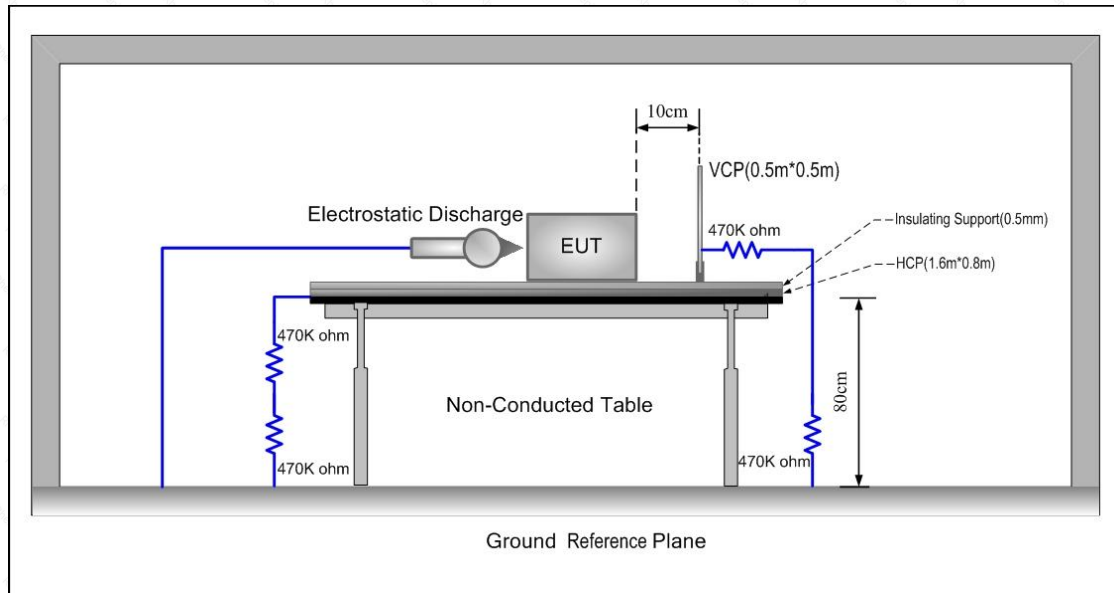

1. Contact discharge was applied only to conductive surfaces of the EUT. Air discharge was applied only to non-conducted surfaces of the EUT.
2. The EUT was put on a 0.8m high wooden table for table-top equipment or 0.1m high for floor standing equipment standing on the ground reference plane (GRP).
3. A horizontal coupling plane(HCP) 1.6m by 0.8m in size was placed on the table, and the EUT with its cables were isolated from the HCP by an insulating support thick than 0.5mm. The VCP 0.5m by 0.5m in size while HCP were constructed from the same material type and thickness as that of the GRP, and connected to the GRP via a 470kΩ resistor at each end. The distance between EUT and any of the other metallic surfaces excepted the GRP, HCP and VCP was greater than 1m.
4. During the contact discharges, the tip of the discharge electrode was touching the EUT before the discharge switch is operated. During the air discharges, the round discharge tip of the discharge electrode was approached as fast as possible to touch the EUT. After each discharge, the ESD generator was removed from the EUT, the generator is then retriggered for a new single discharge. For ungrounded product, a discharge cable with two resistances was used after each discharge to remove remnant electrostatic voltage. 10 times of each polarity single discharge were applied to HCP and VCP.

6.1.2.Results

Test point	Table (T) Floor (F)	Contact (C) Air (A)	Voltage (kV)	Number of discharge	Polarity (+ / -)	Opinion
Air contact	T	A	8	10	+ / -	A
Direct contact	T	C	4	10	+ / -	A
HCP	T	C	4	10	+ / -	A
VCP	T	C	4	10	+ / -	A

A: no loss of function.

6.2. RF Field Strength Susceptibility Test

6.2.1.Measurement procedure

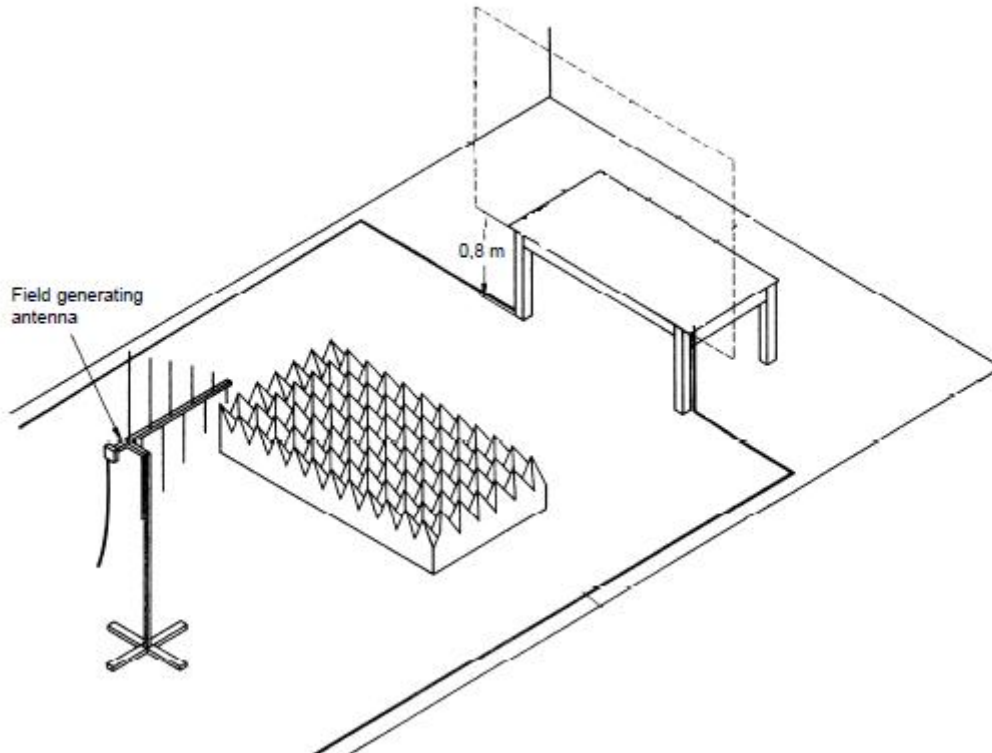

1. The EUT was placed on 0.8m high wooden table for table-top equipment. For floor standing equipment, the EUT was placed on a 0.1m high wooden support above the GRP. The tests normally shall be performed with the generating antenna facing each of four sides of the EUT. When equipment can be used in different orientations (e.g. vertical or horizontal) the test shall be performed on all possible sides of the EUT.
2. The tests are carried out with a field strength by 3 V/m (measured in the unmodulated field) with amplitude modulated signal by a depth of 80 % by a sinusoidal audio signal of 1 kHz. The logarithmic step was 1% and the dwell time was 3s dependent of the EUT cycle time. Test was performed on subcontractor.

6.2.2.Results

Frequency Range	Voltage(RMS) V/m	Sweeping time of radiated	Opinion
80 - 1000 MHz, 1.4GHz-2.7GHz	3	0.0015 decade/s	A

A: no loss of function.

6.3. Electrical Fast Transients/Burst Test

6.3.1.Measurement procedure

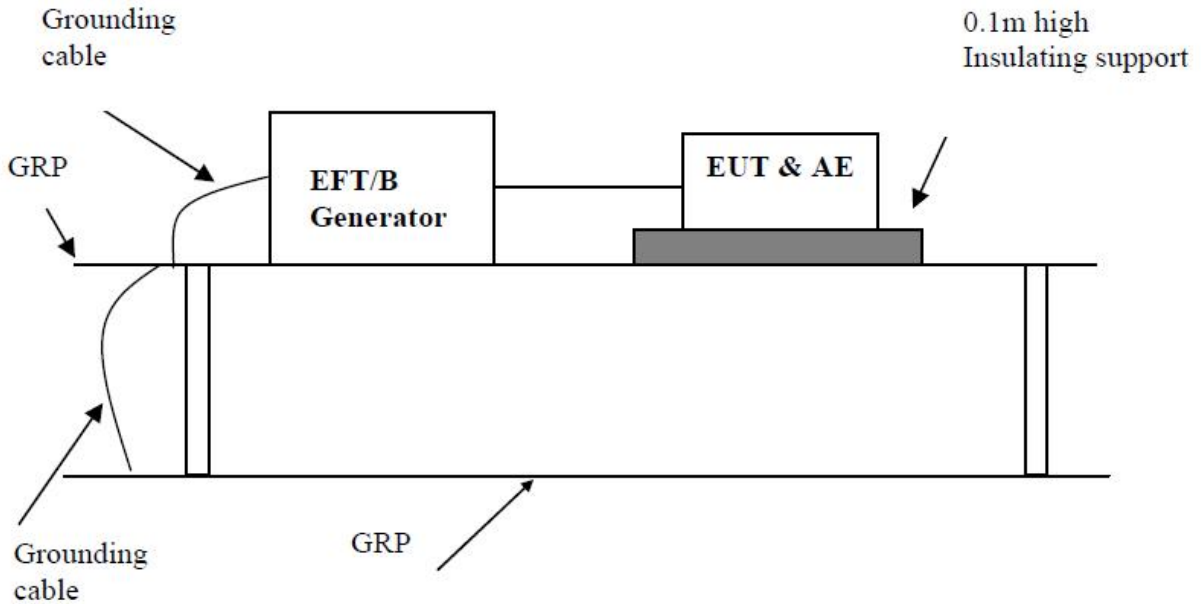

1. The EUT was placed on a ground reference plane (GRP) insulated by an insulating support 0.1 m thick and the GRP was placed on a 0.8m high wooden table for table-top equipment. For floor standing equipment, the EUT was placed on a 0.1m high wooden support above the GRP.
2. The GRP shall project beyond the EUT and the clamp by at least 0.1m on all sides. The distance between the EUT and any other of the metallic surface except the GRP was greater than 0.5m. All cables to the EUT were placed on the insulating support 0.1m above GRP. Cables not subject to EFT were routed as far as possible from cable under test to minimize the coupling between the cables.
3. The length of signal and power cable between the EUT and EFT generator was 0.5m. If the cable is a non-detachable supply cable more than 0.5m, the excess length of this cable shall be folded to avoid a flat coil and situated at a distance of 0.1m above the GRP.

6.3.2.Results

N/A

Test port	Voltage (kV)	Polarity (+ / -)	Duration (s or min)	Waveform Tr / Th	Repetition Frequency (kHz)	Opinion
AC power line						

6.4. Injected Currents Susceptibility Test

6.4.1.Measurement procedure

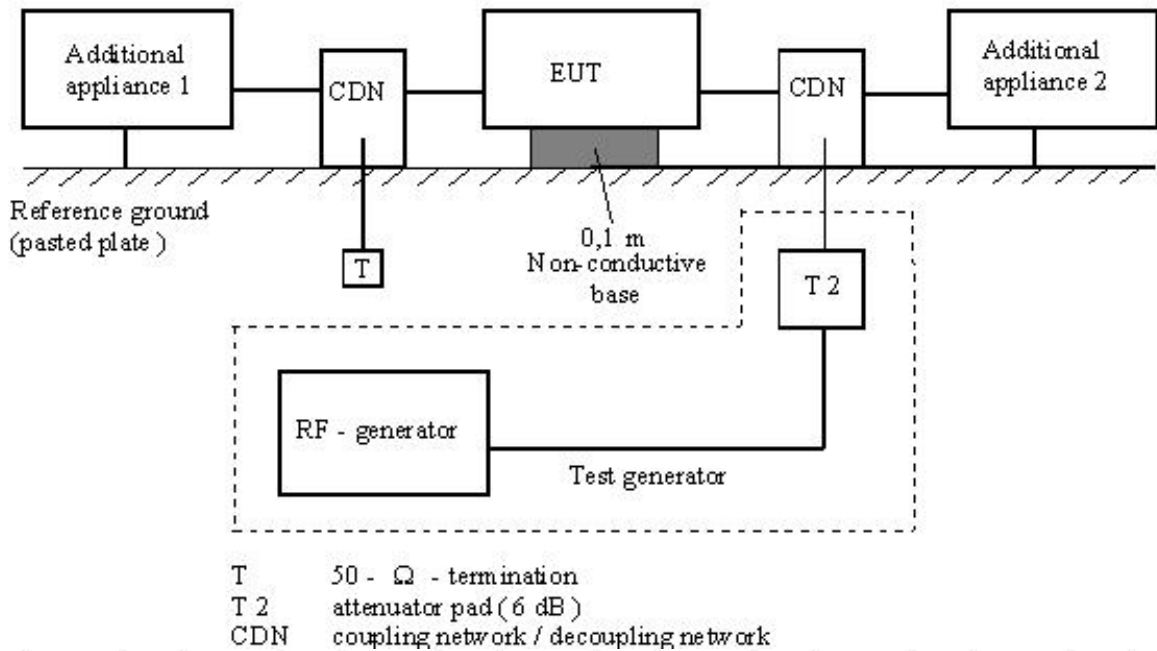

1. The EUT was placed on an insulating support of 0.1m height above a ground reference Plane, arranged and connected to satisfy its functional requirement. All cables exiting the EUT was supported at a height of at least 30 mm above the ground reference plane.
2. The coupling and decoupling devices were required, they were located between 0,1 m and 0,3 m from the EUT. This distance was to be measured horizontally from the projection of the EUT on to the ground reference plane to the coupling and decoupling device.
3. The frequency range was swept from 150 kHz to 80 MHz, using the signal levels established during the setting process, and with the disturbance signal 80 % amplitude modulated with a 1 kHz sine wave, pausing to adjust the RF signal level or to change coupling devices as necessary. Where the frequency was swept incrementally, the step size does not exceed 1 % of the preceding frequency value. The dwell time of the amplitude modulated carrier at each frequency was not less than the time necessary for the EUT to be exercised and to respond, and was not less than 3 s.

6.4.2.Results

N/A

Test port	Voltage (rms) V	Modulation Frequency	Frequency Range	Opinion
AC power line				

A: no loss of function.

6.5.Surge Test

6.5.1.Measurement procedure

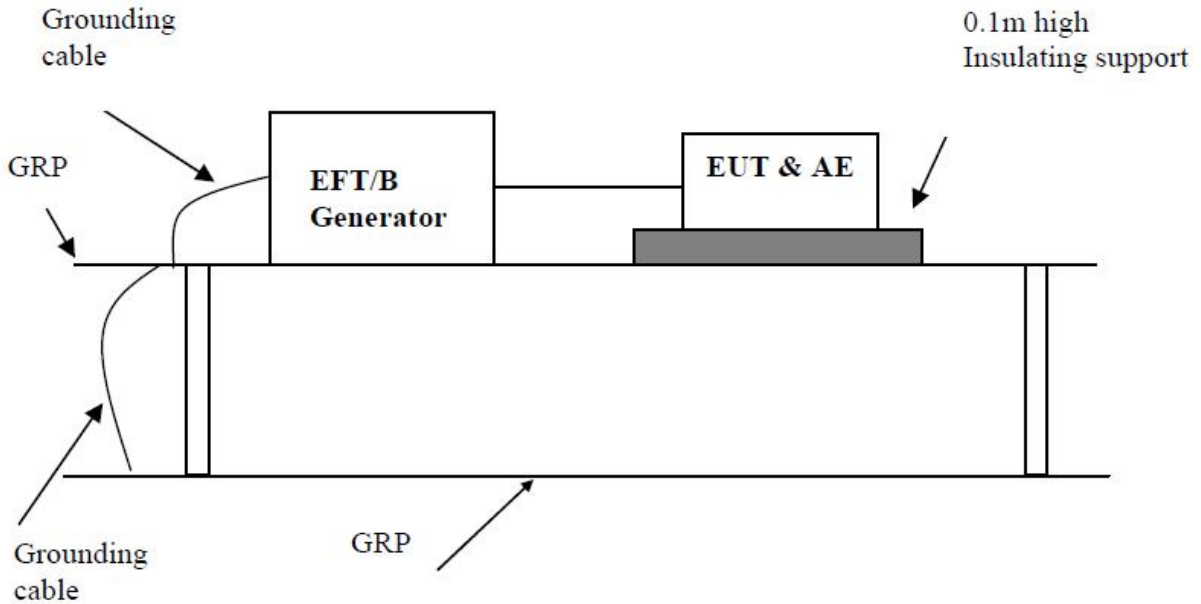

1. The EUT was placed on a ground reference plane (GRP) insulated by an insulating support 0,1 m thick and the GRP was placed on a 0.8m high wooden table for table-top equipment. For floor standing equipment, the EUT was placed on a 0.1m high wooden support above the GRP.
2. The 1,2/50 μ s surge was to be applied to the EUT power supply terminals via the capacitive coupling network. Decoupling networks were required in order to avoid possible adverse effects on equipment not under test that may be powered by the same lines and to provide sufficient decoupling impedance to the surge wave so that the specified wave may be applied on the lines under test.
3. Pulses shall be applied to the a.c. voltage wave as follows; five positive polarity pulses at the 90° phase angle, five negative polarity pulses at the 270° phase angle.

6.5.2.Results

N/A

Test mode	Voltage (kV)	Waveform Tr / Th	Number of pulses	Opinion

A: no loss of function.

6.6. Voltage dips and Interruption

6.6.1. Measurement procedure

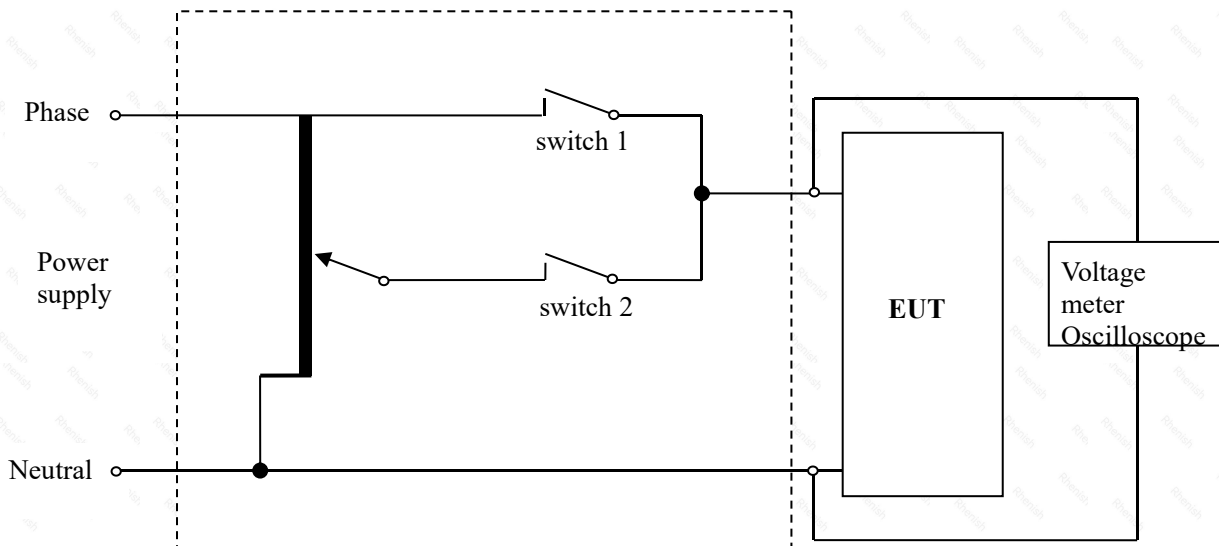

1. The EUT was placed on a ground reference plane (GRP) insulated by an insulating support 0,1 m thick and the GRP was placed on a 0.8m high wooden table for table-top equipment. For floor standing equipment, the EUT was placed on a 0.1m high wooden support above the GRP.
2. The test was performed with the EUT connected to the test generator with the shortest power supply cable as specified by the EUT manufacturer. Changes to the voltage level shall occur at a zero crossing point in the a.c. voltage waveform.
3. The EUT was tested for each selected combination of test level and duration with a sequence of three dips / interruptions with intervals of 10 s minimum. Each representative mode of operation was tested.

6.6.2. Results

N/A

Test level (in %U _r)	Duration (in period of the rated frequency)	Performance criteria	Opinion

A: no loss of function.

B: the appliance would not work normal (darkle) during test, but after test it would recover.

APPENDIX I

Photo

Description: Overall view

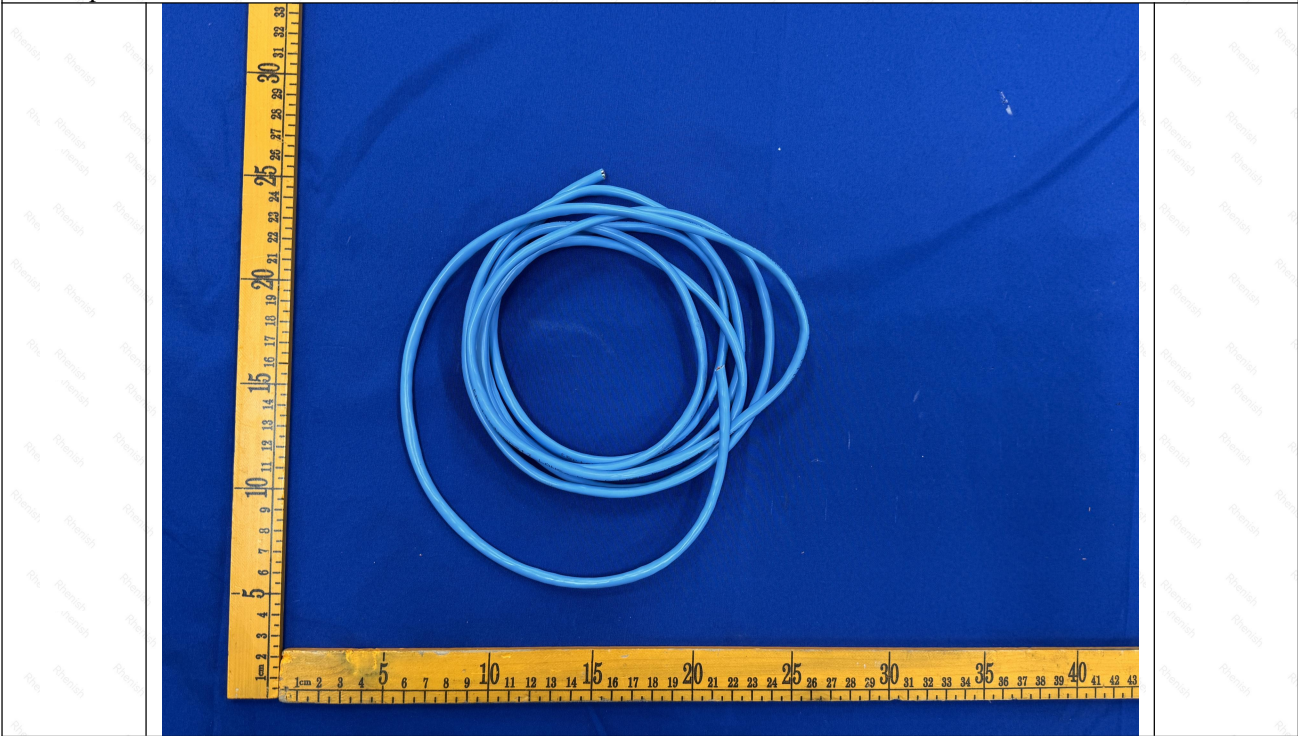

Photo

Description: Overall view



Photo

Description: Overall view

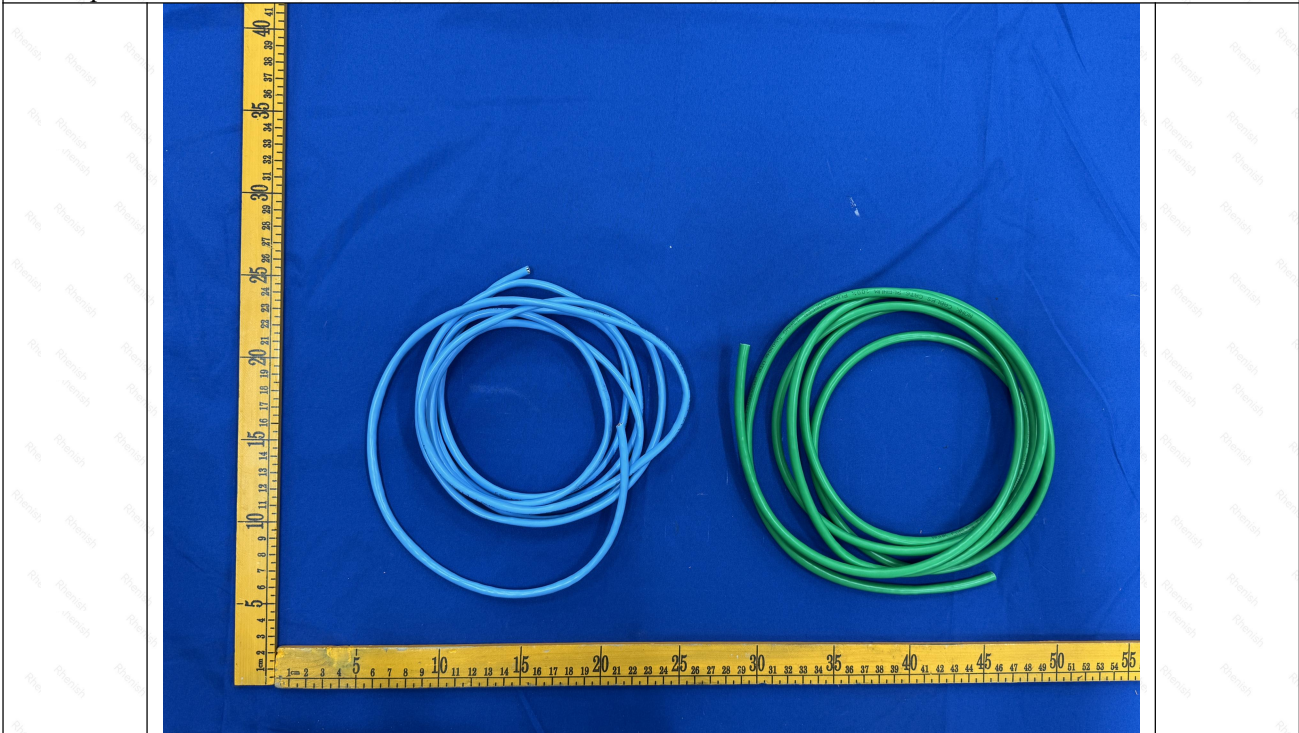

*****END*****